

Military 24-Pin PAL Devices

Features

- Registers with feedback
- Programmable three-state outputs
- Security fuse prevents duplication of logic
- Variety of speed/power options available in same architecture
- Register preload to aid in device testing
- Power-up reset to logical high
- Programmable output polarity
- Product term sharing
- Programmable register or combinatorial outputs
- Dual feedback allows buried state registers or input registers (PAL32VX10)
- Programmable flip-flops allow J-K, S-R, T or D types (PAL32VX10)
- Asynchronous preset/synchronous reset, synchronous preset/asynchronous reset (PAL32VX10)
- Through-hole or surface mount device packaging
- Neutron fluence (permanent damage): 1×10^{13} N/cm²
- Dose rate (transient upset) Junction Isolated Bipolar processes: 2×10^{19} RADs (SI) per sec recovered in 50 to 70 μ s from a 1 μ s pulse

Benefits

- Instant prototyping/zero NRE charge
- Low-cost programmable replacement for TTL logic
- Reduces inventory by reducing chip count
- Programmed on standard PROM/PAL device programmers
- Several software programs available to assist in creating bit pattern designs

Applications

- High speed graphic controllers
- High speed computers
- High frequency state machines
- High frequency counters
- Microprocessor clock generation and interface logic
- DMA controllers
- Asynchronous bus interface
- CRT controllers
- Peripheral/handshaking interface
- Interrupt controllers
- Memory mapped I/O (PAL8L14A)
- Microprocessor decoder (PAL8L14A)

24-Pin PAL Device Speed vs. Power

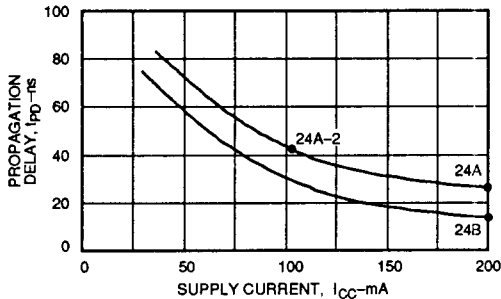

503 144

Register Preload

Register preload is an aid to functional testing, which is usually performed after the device is programmed but before it is installed on the circuit board. Using register preload, the register of a device can be "preloaded" to any desired state value. This is particularly useful in applications where the output is fed back into the array as an input, since it may take many state transitions to reach a desired state in the output register. Register preload also allows the user to set the device to an "illegal" state which cannot be reached through normal state transitions, in order to test for proper recovery.

Power-Up Reset

Another added testability feature found on these Series is power-up reset. Power-up reset makes system initialization simple; registers are reset to logic 0 at power-up, thus all outputs are set to logic 1.

The table below is a brief summary of our current devices that do have register preload and/or power-up reset.

Devices with Register Preload and Power-Up Reset

DEVICE FAMILY	REGISTER PRELOAD	POWER-UP RESET
Exclusive OR 24XA	YES	YES
Shared Product terms 24RS	YES	YES
Asynchronous 24RA	YES	YES
Varied Product terms 24VX*	YES	YES

* The PAL32VX10/10A has power-up preset; registers are set to logical 1 on power up.

Military 24-Pin PAL Device Pinouts

12L10

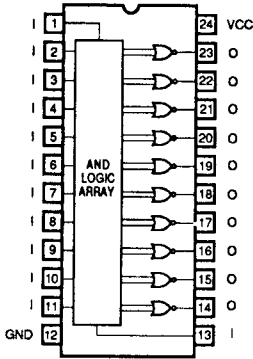

CERDIP CERPACK

12L10

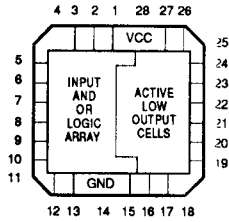

LEADLESS CHIP CARRIER

14L8

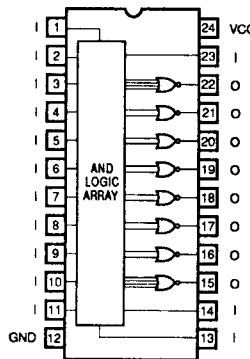

CERDIP CERPACK

14L8

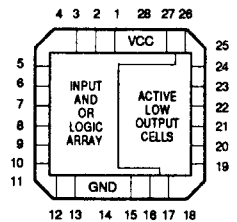

LEADLESS CHIP CARRIER

16L6

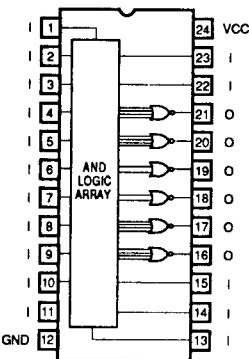

CERDIP CERPACK

16L6

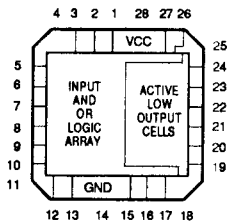

LEADLESS CHIP CARRIER

18L4

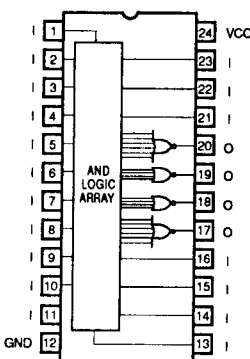

CERDIP CERPACK

18L4

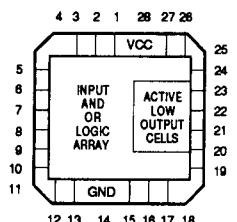

LEADLESS CHIP CARRIER

20L2

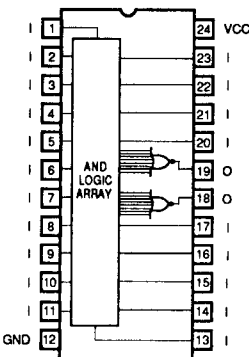

CERDIP CERPACK

20L2

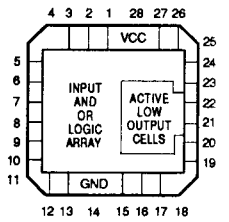

LEADLESS CHIP CARRIER

20C1

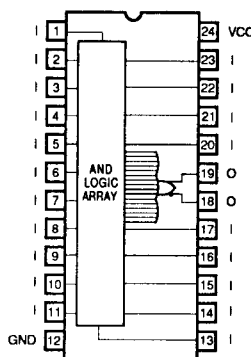

CERDIP CERPACK

20C1

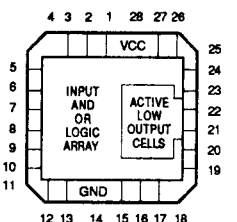

LEADLESS CHIP CARRIER

5

Military 24-Pin PAL Device Pinouts

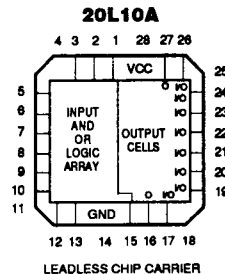
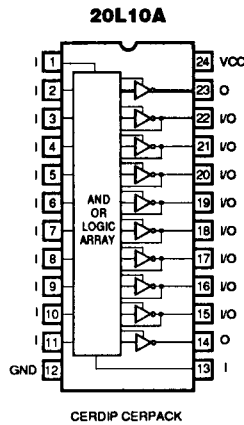
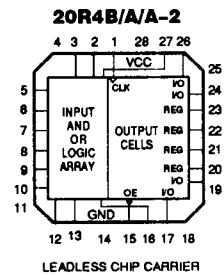
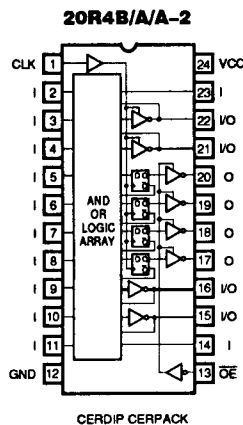
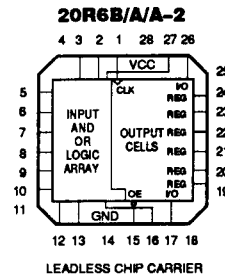
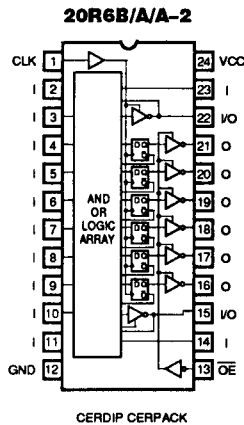
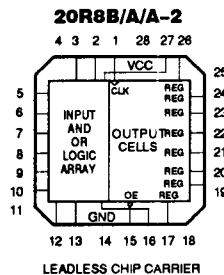
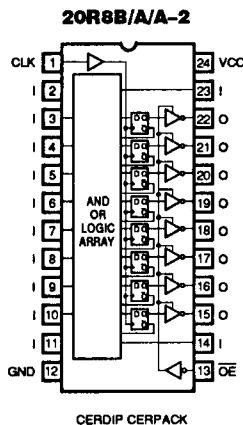
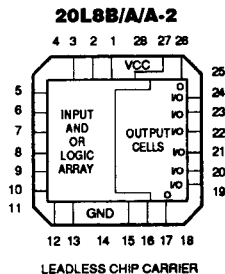
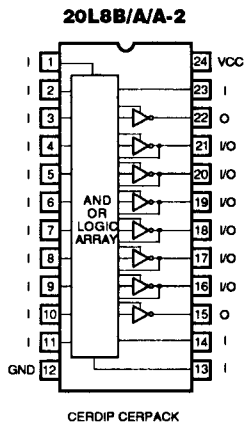
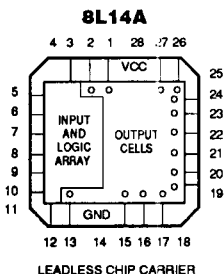
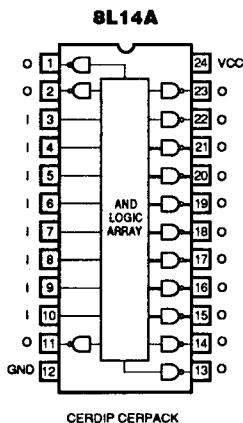

503 157

Military 24-Pin PAL Device Pinouts

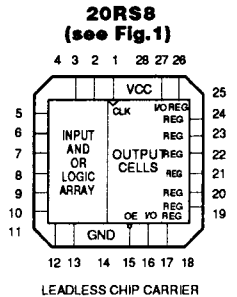
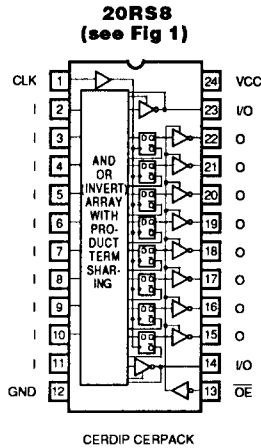
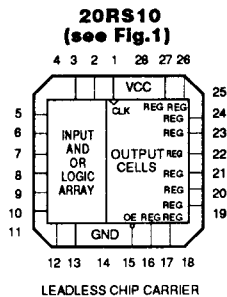
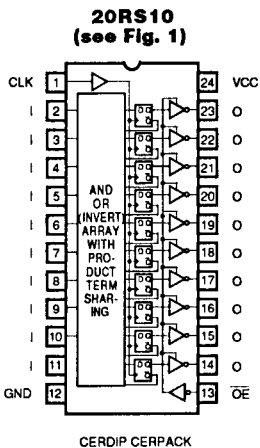
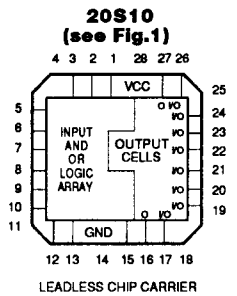
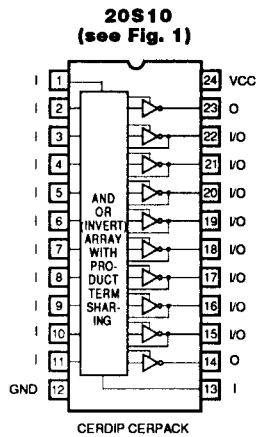
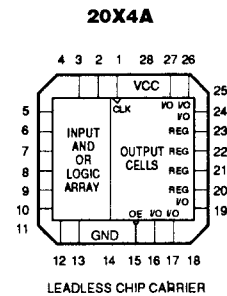
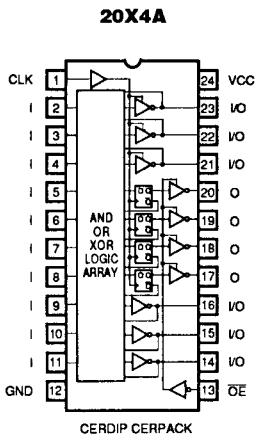
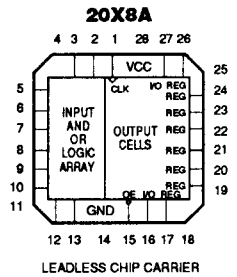
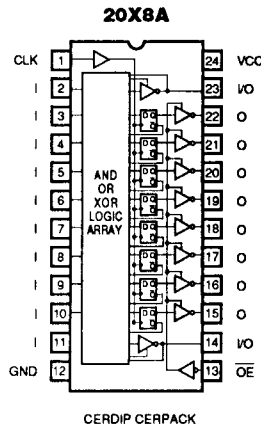
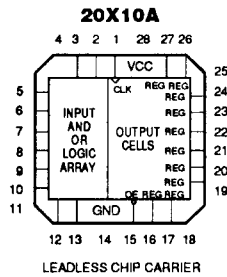
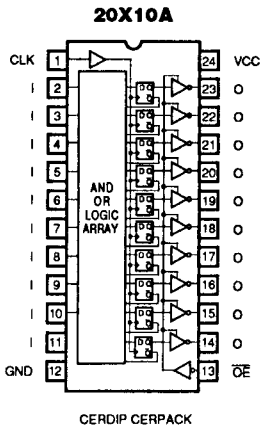

5

Military 24-Pin PAL Device Pinouts

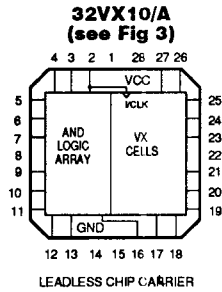
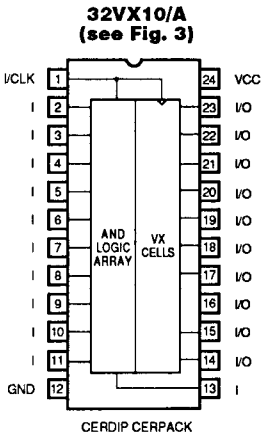
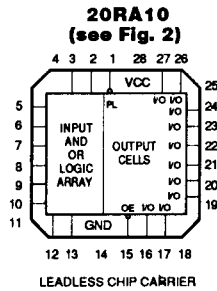
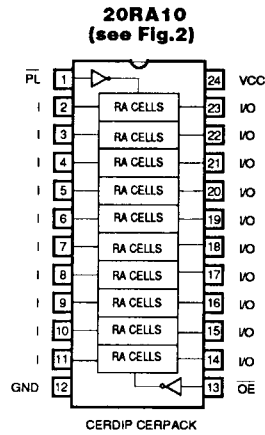
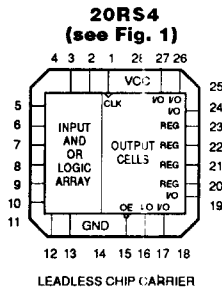
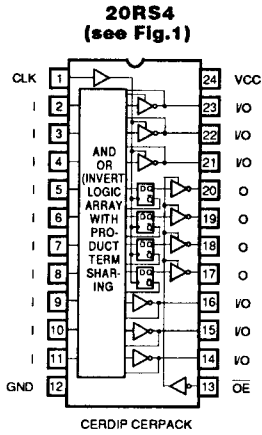

503 181

Military PAL20S10, 20RS10, 20RS8, 20RS4 Series

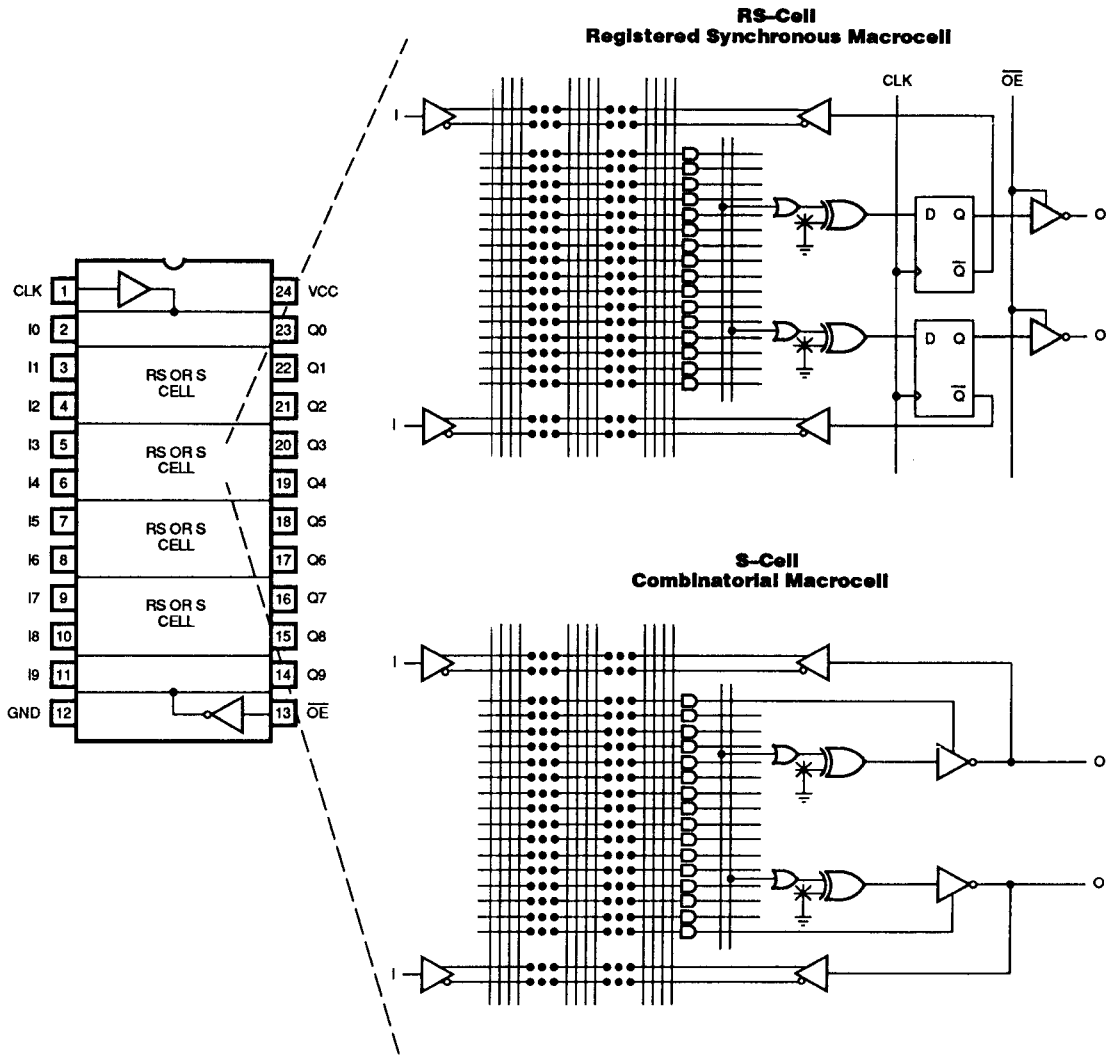

Figure 1.

503 187

5

Military PAL20RA10 Device

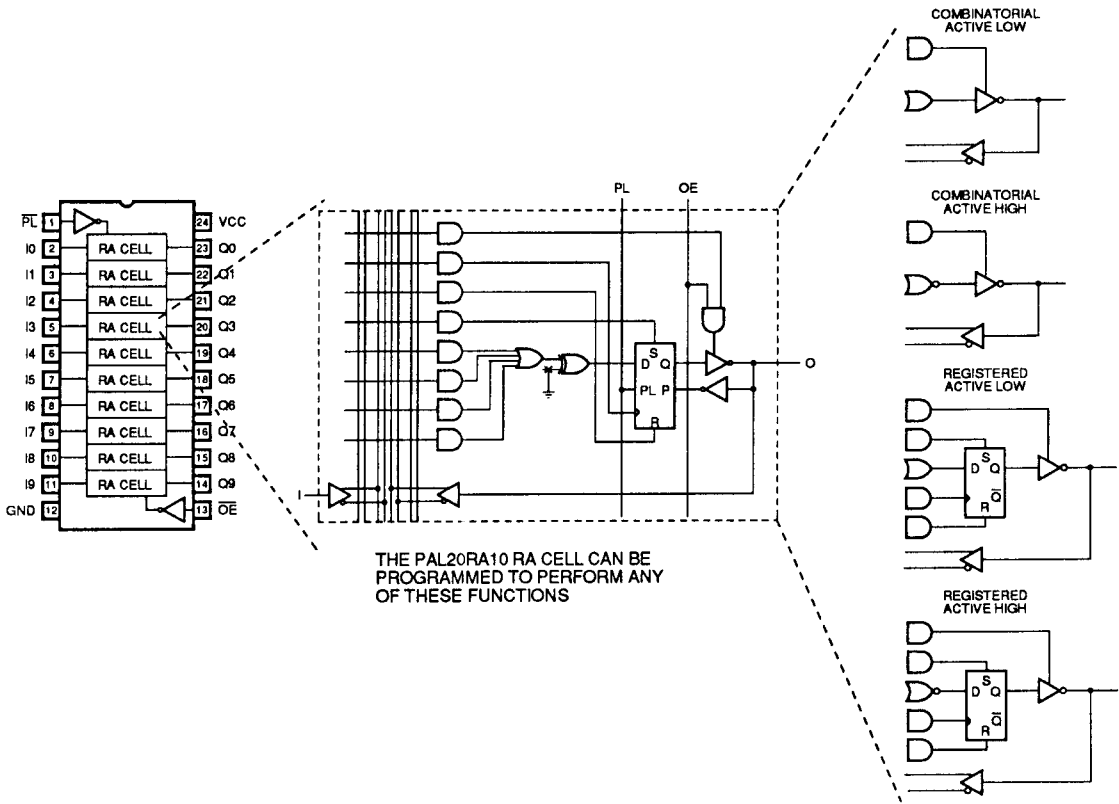

Figure 2.

Military PAL32VX10 Device

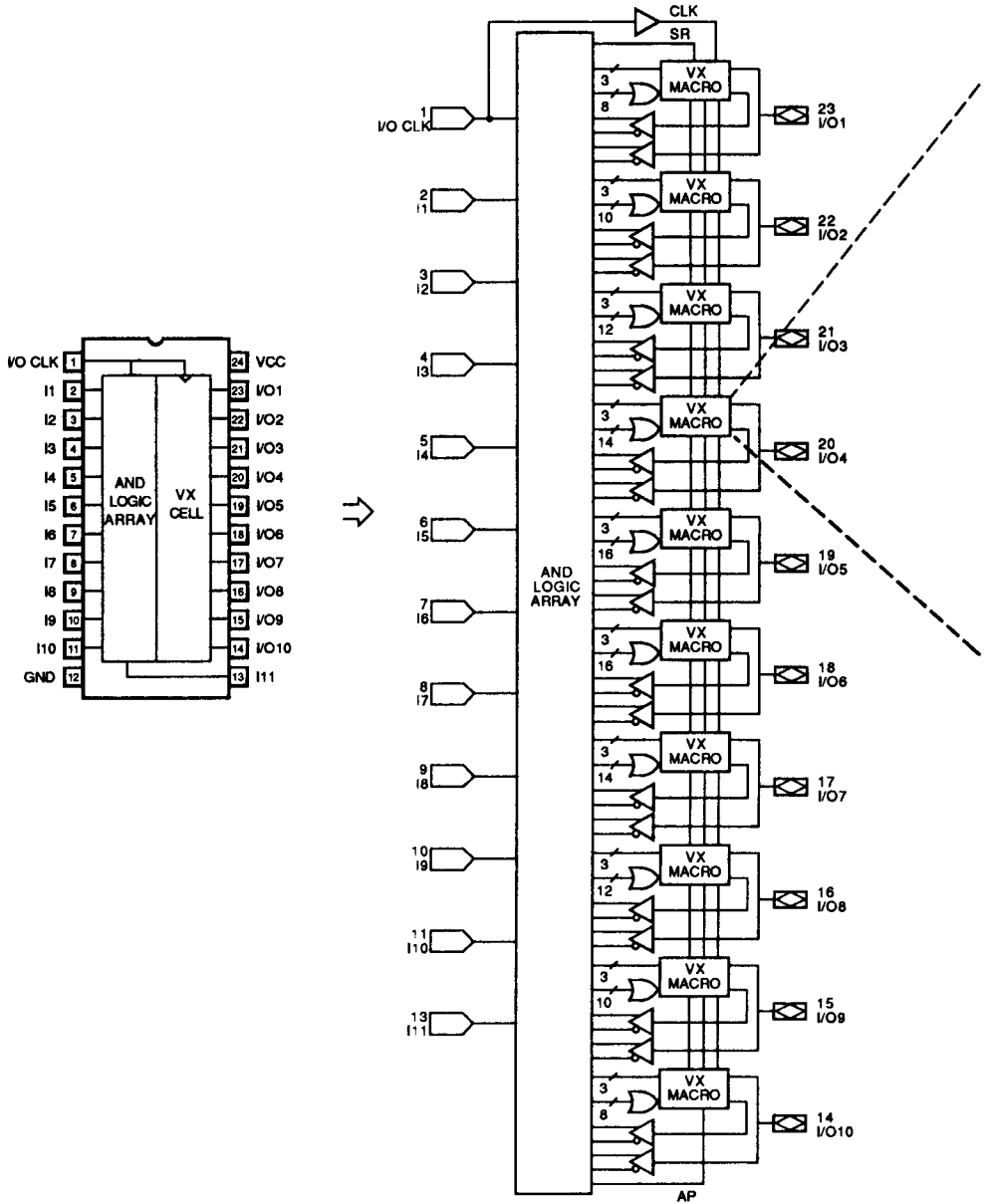
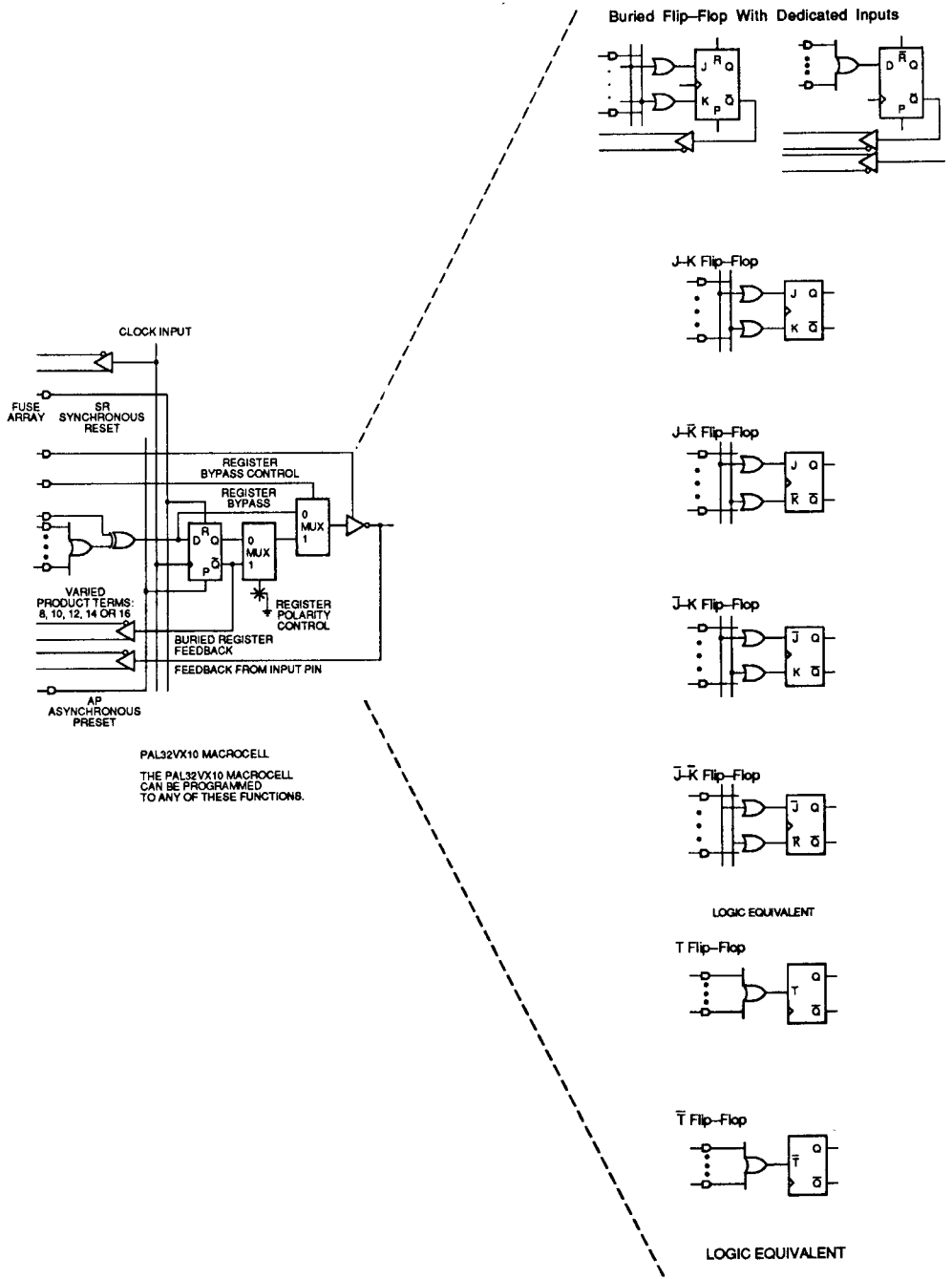

Figure 3.

5

503 191



503 192

Figure 3. (Cont'd.)

Military 24-Pin PAL Devices

Absolute Maximum Ratings

	Operating
Supply voltage V_{cc}	-0.5 V to 7 V
Input voltage	-1.5 V to 5.5 V
Off-state output voltage	5.5 V
Storage temperature	-65°C to +150°C
Maximum junction temperature (T_j)	175°C
Lead temperature (soldering, 10 sec max)	300°C
Maximum current density 5×10^{-5} A/cm ² per Mil-M-38510	< 5×10^{-5} A/cm ²
Maximum $\theta_{jc} = 28^\circ\text{C/W}$ for cerdips per Mil-M-38510	< 28°C/W
Maximum $\theta_{jc} = 22^\circ\text{C/W}$ for flatpacks per Mil-M-38510	< 22°C/W
Maximum $\theta_{jc} = 20^\circ\text{C/W}$ for leadless chip carriers per Mil-M-38510	< 20°C/W

Military Standard 24-Pin PAL Series

PAL12L10, 14L8, 16L6, 18L4, 20L2, 20C1

Can be purchased to military drawing 5962-86804, latest revision in effect.

Operating Conditions

SYMBOL	PARAMETER	MIN	MAX	UNIT
V_{cc}	Supply voltage	4.5	5.5	V
T_A	Operating free-air temperature	-55		°C
T_C	Operating case temperature		125	°C
V_{IL}^*	Low-level input voltage		≤0.8	V
V_{IH}^*	High-level input voltage	≥2.0		V

Note: Virgin array verify of unprogrammed PAL device is performed at 25°C only.

* These are absolute voltages with respect to the ground pin on the device and include all overshoots due to system and/or tester noise.

Electrical Characteristics Over Operating Conditions

SYMBOL	PARAMETER	TEST CONDITIONS		MIN	MAX	UNIT
V_{ic}	Input clamp voltage	$V_{cc} = \text{MIN}$	$I_i = -18 \text{ mA}$		-1.5	V
I_{iL}	Low-level input current	$V_{cc} = \text{MAX}$	$V_i = 0.4 \text{ V}$		-0.25	mA
I_{iH}	High-level input current	$V_{cc} = \text{MAX}$	$V_i = 2.4 \text{ V}$		25	μA
I_i	Maximum input current	$V_{cc} = \text{MAX}$	$V_i = 5.5 \text{ V}$		1	mA
V_{OL}	Low-level output voltage	$V_{cc} = \text{MIN}$	$I_{OL} = 8 \text{ mA}$		0.5	V
V_{OH}	High-level output voltage	$V_{cc} = \text{MIN}$	$I_{OH} = -2 \text{ mA}$	2.4		V
I_{OS}^*	Output short-circuit current	$V_{cc} = 5 \text{ V}$	$V_o = 0.5 \text{ V}$	-30	-130	mA
I_{cc}	Supply current	$V_{cc} = \text{MAX}$			100	mA

*Not more than one output should be shorted at a time and duration of the short circuit should not exceed one second.

Switching Characteristics Over Operating Conditions

SYMBOL	PARAMETER	TEST CONDITIONS	MIN	MAX	UNIT
t_{pd}	Input or feedback to output	$R_1 = 560 \Omega$ $R_2 = 1.1 \text{ K}\Omega$		45	ns

Programmed devices conform to Mil-Std-883, Method 5005, Group A, Subgroups 1, 2, 3, 7, 8, 9, 10 and 11.

Military Decoder 24-Pin PAL Device

PAL8L14A

Operating Conditions

SYMBOL	PARAMETER	MIN	MAX	UNIT
V_{CC}	Supply voltage	4.5	5.5	V
T_A	Operating free-air temperature	-55		°C
T_C	Operating case temperature		125	°C
V_{IL}^*	Low-level input voltage		≤0.8	V
V_{IH}^*	High-level input voltage	≥2.0		V

Note: Virgin array verify of unprogrammed PAL device is performed at 25°C only.

* These are absolute voltages with respect to the ground pin on the device and include all overshoots due to system and/or tester noise.

Electrical Characteristics Over Operating Conditions

SYMBOL	PARAMETER	TEST CONDITIONS		MIN	MAX	UNIT
V_{IC}	Input clamp voltage	$V_{CC} = \text{MIN}$	$I_I = -18 \text{ mA}$		-1.5	V
I_{IL}	Low-level input current	$V_{CC} = \text{MAX}$	$V_I = 0.4 \text{ V}$		-0.25	mA
I_{IH}	High-level input current	$V_{CC} = \text{MAX}$	$V_I = 2.4 \text{ V}$		25	μA
I_I	Maximum input current	$V_{CC} = \text{MAX}$	$V_I = 5.5 \text{ V}$		1	mA
V_{OL}	Low-level output voltage	$V_{CC} = \text{MIN}$	$I_{OL} = 8 \text{ mA}$		0.5	V
V_{OH}	High-level output voltage	$V_{CC} = \text{MIN}$	$I_{OH} = -2 \text{ mA}$	2.4		V
I_{OS}^*	Output short-circuit current	$V_{CC} = 5 \text{ V}$	$V_O = 0.5 \text{ V}$	-30	-130	mA
I_{CC}	Supply current	$V_{CC} = \text{MAX}$			100	mA

*Not more than one output should be shorted at a time and duration of the short circuit should not exceed one second.

Switching Characteristics Over Operating Conditions

SYMBOL	PARAMETER	TEST CONDITIONS	MIN	MAX	UNIT
t_{PD}	Input to output propagation delay	$R_1 = 560 \Omega$ $R_2 = 1.1 \text{ K}\Omega$		30	ns

Programmed devices conform to Mil-Std-883, Method 5005, Group A, Subgroups 1, 2, 3, 7, 8, 9, 10 and 11.

Military Very High Speed 24-Pin PAL Series

PAL20L8B, 20R8B, 20R6B, 20R4B

Can be purchased to standard military drawing 5962-87671, latest revision in effect.

Military High Speed 24-Pin PAL Series

PAL20L8A, 20R8A, 20R6A, 20R4A

Can be purchased to standard military drawing 84129, latest revision in effect.

Operating Conditions

SYMBOL	PARAMETER	24 B		24 A		UNIT
		MIN	MAX	MIN	MAX	
V_{CC}	Supply voltage	4.5	5.5	4.5	5.5	V
T_A	Operating free-air temperature	-55		-55		°C
T_c	Operating case temperature		125		125	°C
t_w^\dagger	Width of clock (except 20L8)	Low, t_{wl}	12	20		ns
		High, t_{wh}	12	20		ns
t_{su}^\dagger	Set up time from input or feedback to clock (except 20L8)	20		30		ns
t_h^\dagger	Hold time	0		0		ns
V_{IL}^*	Low-level input voltage		≤0.8		≤0.8	V
V_{IH}^*	High-level input voltage	≥2.0		≥2.0		V

Note: Virgin array verify of unprogrammed PAL device is performed at 25°C only.

* These are absolute voltages with respect to the ground pin on the device and include all overshoots due to system and/or tester noise.

† These are device set-up conditions, which are measured during initial qualification, and are not directly tested.

Electrical Characteristics Over Operating Conditions

SYMBOL	PARAMETER	TEST CONDITIONS		MIN	MAX	UNIT
V_{IC}	Input clamp voltage	$V_{CC} = 4.5\text{ V}$	$I_I = -18\text{ mA}$		-1.5	V
I_{IL}^*	Low-level input current	$V_{CC} = 5.5\text{ V}$	$V_I = 0.4\text{ V}$		-0.25	mA
I_{IH}^*	High-level input current	$V_{CC} = 5.5\text{ V}$	$V_I = 2.4\text{ V}$		25	μA
I_I	Maximum input current	$V_{CC} = 5.5\text{ V}$	$V_I = 5.5\text{ V}$		1.0	mA
V_{OL}	Low-level output voltage	$V_{CC} = 4.5\text{ V}$	$I_{OL} = 12\text{ mA}$		0.5	V
V_{OH}	High-level output voltage	$V_{CC} = 4.5\text{ V}$	$I_{OH} = -2\text{ mA}$	2.4		V
I_{OZ}^*	Offstate output current	$V_{CC} = 5.5\text{ V}$	$V_O = 0.4\text{ V}$		-100	μA
I_{OHZ}^*			$V_O = 2.4\text{ V}$		100	
I_{OS}^{**}	Output short-circuit current	$V_{CC} = 5.5\text{ V}$	$V_O = 0.5\text{ V}$	-30	-130	mA
I_{CC}	Supply current	$V_{CC} = 5.5\text{ V}$			210	mA

* I/O pin leakage is worst case of IIX or IOZX; i.e., IIL and IOZH.

** Not more than one output should be shorted at a time and duration of the short circuit should not exceed one second.

Military Very High Speed 24-Pin PAL Series

PAL20L8B, 20R8B, 20R6B, 20R4B

Military High Speed 24-Pin PAL Series

PAL20L8A, 20R8A, 20R6A, 20R4A

Switching Characteristics Over operating conditions

SYMBOL	PARAMETER	TEST CONDITIONS	24 B		24 A		UNIT	
			MIN	MAX	MIN	MAX		
t_{PD}	Input or feedback to output (except 20R8)	$R_1 = 390 \Omega$ $R_2 = 750 \Omega$		20		30	ns	
t_{CLK}	Clock to output or feedback (except 20L8)			15		20	ns	
t_{PZK}	Pin 13 to output enable (except 20L8)				20		25	ns
t_{PXZ}	Pin 13 to output disable (except 20L8)				20		25	ns
t_{PZX}	Input to output enable (except 20R8)				25		30	ns
t_{PXZ}	Input to output disable (except 20R8)				20		30	ns
f_{MAX}^*	State machine maximum operating frequency (except 20L8)		28.5		20		MHz	
	Data path register maximum operating frequency (except 20L8)		41.6		25			

* f_{MAX} is calculated and measured on initial qualifications only.

$$f_{MAX} \text{ (state machine)} = 1/[t_{su} + t_{CLK}]$$

$$f_{MAX} \text{ (data path register)} = 1/[t_{WL} + t_{WH}] \text{ or } 1/t_{su} + t_h, \text{ whichever is smaller.}$$

Programmed devices conform to Mil-Std-883, Method 5005, Group A, Subgroups 1, 2, 3, 7, 8, 9, 10 and 11.

Military Half-Power 24A-Pin Series

PAL20L8A-2, 20R8A-2, 20R6A-2, 20R4A-2

Can be purchased to standard military drawing 84129 latest revision in effect.

Operating Conditions

SYMBOL	PARAMETER	MIN	MAX	UNIT
V_{CC}	Supply voltage	4.5	5.5	V
T_A	Operating free-air temperature	-55	125	°C
t_w^\dagger	Width of clock (except 20L8)	Low	25	ns
		High	25	ns
t_{su}^\dagger	Setup time from input or feedback to clock (except 20L8)	50		ns
t_h^\dagger	Hold time	0		ns
V_{IL}^*	Low-level input voltage		≤0.8	V
V_{IH}^*	High-level input voltage	≥2.0		V

Note: Virgin array verify of unprogrammed PAL device is performed at 25°C only.

* These are absolute voltages with respect to the ground pin on the device and include all overshoots due to system and/or tester noise.

† These are device set-up conditions, which are measured during initial qualification, and are not directly tested.

Electrical Characteristics Over Operating Conditions

SYMBOL	PARAMETER	TEST CONDITIONS		MIN	MAX	UNIT
V_{IC}	Input clamp voltage	$V_{CC} = \text{MIN}$	$I_I = -18 \text{ mA}$		-1.5	V
I_{IL}^*	Low-level input current	$V_{CC} = \text{MAX}$	$V_I = 0.4 \text{ V}$		-0.25	mA
I_{IH}^*	High-level input current	$V_{CC} = \text{MAX}$	$V_I = 2.4 \text{ V}$		25	μA
I_I	Maximum input current	$V_{CC} = \text{MAX}$	$V_I = 5.5 \text{ V}$		1	mA
V_{OL}	Low-level output voltage	$V_{CC} = \text{MIN}$	$I_{OL} = 12 \text{ mA}$		0.5	V
V_{OH}	High-level output voltage	$V_{CC} = \text{MIN}$	$I_{OH} = -2 \text{ mA}$	2.4		V
I_{OZL}^*	Offstate output current	$V_{CC} = \text{MAX}$	$V_O = 0.4 \text{ V}$		-100	μA
I_{OZH}^*			$V_O = 2.4 \text{ V}$		100	μA
I_{OS}^{**}	Output short-circuit current	$V_{CC} = 5 \text{ V}$	$V_O = 0.5 \text{ V}$	-30	-130	mA
I_{CC}	Supply Current	$V_{CC} = \text{MAX}$			105	mA

* I/O pin leakage is worst case of IIX or IOZX; i.e., IIL and IOZH.

** Not more than one output should be shorted at a time and duration of the short circuit should not exceed one second.

Military Half-Power 24A-Pin Series

PAL20L8A-2, 20R8A-2, 20R6A-2, 20R4A-2

Switching Characteristics Over Operating Conditions

SYMBOL	PARAMETER	TEST CONDITIONS	MIN	MAX	UNIT
t_{PD}	Input or feedback to output (except 20R8)	$R_1 = 390 \Omega$ $R_2 = 750 \Omega$		50	ns
t_{CLK}	Clock to output or feedback (except 20L8)			25	ns
t_{PZX}	Pin 13 to output enable (except 20L8)			25	ns
t_{PXZ}	Pin 13 to output disable (except 20L8)			25	ns
t_{PZX}	Input to output enable (except 20R8)			45	ns
t_{PXZ}	Input to output disable (except 20R8)			45	ns
f_{MAX}^*	State machine maximum operating frequency (except 20L8)		13.3		MHz
	Data path register maximum operating frequency (except 20L8)		20		

* f_{MAX} is calculated and measured on initial qualifications only.

$$f_{MAX} \text{ (state machine)} = 1/(t_{su} + t_{CLK})$$

$$f_{MAX} \text{ (data path register)} = 1/(t_{WL} + t_{WH}) \text{ or } 1/t_{su} + t_{th}, \text{ whichever is smaller.}$$

Programmed devices conform to Mil-Std-883, Method 5005, Group A, Subgroups 1, 2, 3, 7, 8, 9, 10 and 11.

5

Military High Speed 24XA-Pin Series

PAL20L10A, 20X10A, 20X8A, 20X4A

Can be purchased to standard military print 84129, latest revision in effect.

Operating Conditions

SYMBOL	PARAMETER	MIN	MAX	UNIT
V_{CC}	Supply voltage	4.5	5.5	V
T_A	Operating free-air temperature	-55		°C
T_C	Operating case temperature		125	°C
t_w^\dagger	Width of clock (except 20L10)	Low	35	ns
		High	20	
t_{su}^\dagger	Setup time from input or feedback to clock (except 20L10)	40		ns
t_h^\dagger	Hold time	0		ns
V_{IL}^*	Low-level input voltage		≤0.8	V
V_{IH}^*	High-level input voltage	≥2.0		V

Note: Virgin array verify of unprogrammed PAL device is performed at 25°C only.

* These are absolute voltages with respect to the ground pin on the device and include all overshoots due to system and/or tester noise.

† These are device set-up conditions, which are measured during initial qualification, and are not directly tested.

Electrical Characteristics Over Operating Conditions

SYMBOL	PARAMETER	TEST CONDITIONS		MIN	MAX	UNIT
V_{IC}	Input clamp voltage	$V_{CC} = \text{MIN}$	$I_i = -18 \text{ mA}$		-1.5	V
I_{IL}^*	Low-level input current	$V_{CC} = \text{MAX}$	$V_i = 0.4 \text{ V}$		-0.25	mA
I_{IH}^*	High-level input current	$V_{CC} = \text{MAX}$	$V_i = 2.4 \text{ V}$		25	μA
I_i	Maximum input current	$V_{CC} = \text{MAX}$	$V_i = 5.5 \text{ V}$		1	mA
V_{OL}	Low-level output voltage	$V_{CC} = \text{MIN}$	$I_{OL} = 12 \text{ mA}$		0.5	V
V_{OH}	High-level output voltage	$V_{CC} = \text{MIN}$	$I_{OH} = -2 \text{ mA}$	2.4		V
I_{OZL}^*	Off-state output current	$V_{CC} = \text{MAX}$	$V_o = 0.4 \text{ V}$		-100	μA
I_{OZH}^*			$V_o = 2.4 \text{ V}$		100	
I_{OS}^{**}	Output short-circuit current	$V_{CC} = 5 \text{ V}$	$V_o = 0.5 \text{ V}$	-30	-130	mA
I_{CC}	Supply current	$V_{CC} = \text{MAX}$	20X10A, 20X8A, 20X4A		180	mA
			20L10A		165	

* I/O pin leakage is worst case of IIX or IOZX; i.e., IIL and IOZH.

** Not more than one output should be shorted at a time and duration of the short circuit should not exceed one second.

Military High Speed 24XA-Pin Series

PAL20L10A, 20X10A, 20X8A, 20X4A

Switching Characteristics Over Operating Conditions

SYMBOL	PARAMETER	TEST CONDITIONS	MIN	MAX	UNIT
t_{PD}	20L10A, 20X8A, 20X4A Input or feedback to output (except 20X10)	$R_1 = 390 \Omega$ $R_2 = 750 \Omega$		35	ns
t_{CLK}	Clock to output or feedback (except 20L10)			25	ns
t_{PZX}	Pin 13 to output enable (except 20L10)			25	ns
t_{PXZ}	Pin 13 to output disable (except 20L10)			25	ns
t_{PZX}	Input to output enable (except 20X10)			35	ns
t_{PXZ}	Input to output disable (except 20X10)			35	ns
f_{MAX}^*	State machine maximum operating frequency (except 20L10)			15.4	MHz
	Data path register maximum operating frequency (except 20L10)			18.2	

* f_{MAX} is calculated and measured on initial qualifications only.

$$f_{MAX} \text{ (state machine)} = 1/[t_{su} + t_{clk}]$$

$$f_{MAX} \text{ (data path register)} = 1/[t_{wl} + t_{wh}] \text{ or } 1/[t_{su} + t_h], \text{ whichever is smaller.}$$

Programmed devices conform to Mil-Std-883, Method 5005, Group A, Subgroups 1, 2, 3, 7, 8, 9, 10 and 11.

5

Military 24RS-Pin Series

PAL20S10, 20RS10, 20RS8, 20RS4

Standard military 5962-87530 is in the process of being generated—Contact the factory.

Operating Conditions

SYMBOL	PARAMETER	MIN	MAX	UNIT
V_{CC}	Supply voltage	4.5	5.5	V
T_A	Operating free-air temperature	-55		°C
T_C	Operating case temperature		125	°C
t_w^\dagger	Width of clock (except 20S10)	Low	20	ns
		High	20	
t_{su}^\dagger	Setup time from input or feedback to clock (except 20S10)	40		ns
t_h^\dagger	Hold time	0		ns
V_L^*	Low-level input voltage		≤0.8	V
V_{IH}^*	High-level input voltage	≥2.0		V

Note: Virgin array verify of unprogrammed PAL device is performed at 25°C only.

* These are absolute voltages with respect to the ground pin on the device and include all overshoots due to system and/or tester noise.

† These are device set-up conditions, which are measured during initial qualification, and are not directly tested.

Electrical Characteristics Over Operating Conditions

SYMBOL	PARAMETER	TEST CONDITIONS		MIN	MAX	UNIT
V_{IC}	Input clamp voltage	$V_{CC} = \text{MIN}$	$I_I = -18 \text{ mA}$		-1.5	V
I_{IL}^*	Low-level input current	$V_{CC} = \text{MAX}$	$V_I = 0.4 \text{ V}$		-0.25	mA
I_{IH}^*	High-level input current	$V_{CC} = \text{MAX}$	$V_I = 2.4 \text{ V}$		25	μA
I_I	Maximum input current	$V_{CC} = \text{MAX}$	$V_I = 5.5 \text{ V}$		1	mA
V_{OL}	Low-level output voltage	$V_{CC} = \text{MIN}$	$I_{OL} = 12 \text{ mA}$		0.5	V
V_{OH}	High-level output voltage	$V_{CC} = \text{MIN}$	$I_{OH} = -2 \text{ mA}$	2.4		V
I_{OZL}^*	Off-state output current	$V_{CC} = \text{MAX}$	$V_O = 0.4 \text{ V}$		-100	μA
I_{OZH}^*			$V_O = 2.4 \text{ V}$		100	
I_{OS}^{**}	Output short-circuit current	$V_{CC} = 5 \text{ V}$	$V_O = 0.5 \text{ V}$	-30	-130	mA
I_{CC}	Supply current	$V_{CC} = \text{MAX}$			240	mA

* I/O pin leakage is worst case of IIX or IOZX; i.e., IIL and IOZH.

** Not more than one output should be shorted at a time and duration of the short circuit should not exceed one second.

Military 24RS-Pin Series

PAL20S10, 20RS10, 20RS8, 20RS4

Switching Characteristics Over Operating Conditions

SYMBOL	PARAMETER	TEST CONDITIONS	MIN	MAX	UNIT
t_{PD}	Input or feedback to output (except 20RS10)	Polarity fuse intact		40	ns
		Polarity fuse Blown		45	
t_{CLK}	Clock to output or feedback (except 20S10)			20	ns
t_{PZX}	Pin 13 to output enable (except 20S10)	$R_1 = 390 \Omega$		25	ns
t_{PXZ}	Pin 13 to output disable (except 20S10)	$R_2 = 750 \Omega$		25	ns
t_{PZX}	Input to output enable (except 20RS10)			35	ns
t_{PXZ}	Input to output disable (except 20RS10)			30	ns
f_{MAX}^*	State machine maximum operating frequency (except 20S10)		16.7		MHz
	Data path register maximum frequency (except 20S10)		25		

* f_{MAX} is calculated and measured on initial qualifications only.

$$f_{MAX} \text{ (state machine)} = 1/[t_{BU} + t_{CLK}]$$

$$f_{MAX} \text{ (data path register)} = 1/[t_{WL} + t_{WH}] \text{ or } 1/[t_{BU} + t_r], \text{ whichever is smaller.}$$

Programmed devices conform to Mil-Std-883, Method 5005, Group A, Subgroups 1, 2, 3, 7, 8, 9, 10 and 11.

Military 24RA-Pin Device

PAL20RA10

Standard military 5962-86803 is in the process of being generated—Contact the factory.

Operating Conditions

SYMBOL	PARAMETER		MIN	MAX	UNIT
V_{CC}	Supply voltage		4.5	5.5	V
T_A	Operating free-air temperature		-55		°C
T_C	Operating case temperature			125	°C
t_w^\dagger	Width of clock	Low	25		ns
		High	25		
t_{wp}^\dagger	Preload pulse width		45		ns
t_{su}^\dagger	Setup time from input or feedback to clock		25		ns
t_{sup}^\dagger	Preload setup time		30		ns
t_h^\dagger	Hold time	Polarity fuse intact	10		ns
		Polarity fuse blown	0		
t_{hp}^\dagger	Preload hold time		30		ns
V_{IL}^*	Low-level input voltage			≤0.8	V
V_{IH}^*	High-level input voltage		≥2.0		V

Note: Virgin array verify of unprogrammed PAL device is performed at 25°C only.

* These are absolute voltages with respect to the ground pin on the device and include all overshoots due to system and/or tester noise.

† These are device set-up conditions, which are measured during initial qualification, and are not directly tested.

Electrical Characteristics Over Operating Conditions

SYMBOL	PARAMETER	TEST CONDITIONS		MIN	TYP	MAX	UNIT
V_{IC}	Input clamp voltage	$V_{CC} = \text{MIN}$	$I_I = -18 \text{ mA}$			-1.5	V
I_{IL}^*	Low-level input current	$V_{CC} = \text{MAX}$	$V_I = 0.4 \text{ V}$			-0.25	mA
I_{IH}^*	High-level input current	$V_{CC} = \text{MAX}$	$V_I = 2.4 \text{ V}$			25	μA
I_I	Maximum input current	$V_{CC} = \text{MAX}$	$V_I = 5.5 \text{ V}$			1	mA
V_{OL}	Low-level output voltage	$V_{CC} = \text{MIN}$	$I_{OL} = 8 \text{ mA}$			0.5	V
V_{OH}	High-level output voltage	$V_{CC} = \text{MIN}$	$I_{OH} = -2 \text{ mA}$	2.4			V
I_{OZL}^*	Off-state output current	$V_{CC} = \text{MAX}$	$V_O = 0.4 \text{ V}$			-100	μA
			$V_O = 2.4 \text{ V}$			100	
I_{OS}^{**}	Output short-circuit current	$V_{CC} = 5 \text{ V}$	$V_O = 0.5 \text{ V}$	-30		-130	mA
I_{CC}	Supply current	$V_{CC} = \text{MAX}$				200	mA

* I/O pin leakage is worst case of IIX or IOZX; i.e., IIL and IOZH.

** Not more than one output should be shorted at a time and duration of the short circuit should not exceed one second.

Military 24RA-Pin Device

PAL20RA10

Switching Characteristics Over Operating Conditions

SYMBOL	PARAMETER		TEST CONDITIONS	MIN	MAX	UNIT
t _{PD}	Input or feedback to output	Polarity fuse intact	R ₁ = 560 Ω R ₂ = 1.1 KΩ		35	ns
		Polarity fuse Blown			40	
t _{CLK}	Clock to output or feedback			35	ns	
t _S	Input to asynchronous set			40	ns	
t _R	Input to asynchronous reset			45	ns	
t _{PZX}	Pin 13 to output enable			25	ns	
t _{PXZ}	Pin 13 to output disable			25	ns	
t _{PZX}	Input to output enable			35	ns	
t _{PXZ}	Input to output disable			35	ns	
f _{MAX} *	State machine maximum operating frequency				16.7	MHz
	Data path register maximum frequency			20		

*f_{MAX} is calculated and measured on initial qualifications only.

$$f_{MAX} \text{ (state machine)} = 1/[t_{SU} + t_{CLK}]$$

$$f_{MAX} \text{ (data path register)} = 1/[t_{WL} + t_{WH}] \text{ or } 1/[t_{SU} + t_{P}], \text{ whichever is smaller.}$$

Programmed devices conform to Mil-Std-883, Method 5005, Group A, Subgroups 1, 2, 3, 7, 8, 9, 10 and 11.

ADVANCE INFORMATION

Operating Conditions

SYMBOL	PARAMETER		STD		A		UNIT
			MIN	MAX	MIN	MAX	
V_{CC}	Supply voltage		4.5	5.5	4.5	5.5	V
T_A	Operating free-air temperature		-55	125	-55	125	°C
t_w^\dagger	Width of clock	Low	25		23		ns
		High	25		23		
t_{su}^\dagger	Setup time from input or feedback to clock	Product terms P_1 - P_n , SR	35		30		ns
		Product term XOR	40		35		
t_h^\dagger	Hold time		0		0		ns
t_{pw}^\dagger	Asynchronous preset width		35		30		ns
t_{pr}^\dagger	Asynchronous preset recovery time		35		30		ns
t_{sr}^\dagger	Synchronous reset recovery time		35		30		ns
V_{IL}^*	Low-level input voltage			≤0.8		≤0.8	V
V_{IH}^*	High-level input voltage		≥2.0		≥2.0		V

Note: Virgin array verify of unprogrammed PAL device is performed at 25°C only.

* These voltages apply with respect to the ground pin on the device and include all overshoots due to system and/or tester noise.

† These are device set-up conditions, which are measured during initial qualification, and are not directly tested.

Electrical Characteristics Over Operating Conditions

SYMBOL	PARAMETER	TEST CONDITIONS		MIN	MAX	UNIT
V_{IC}	Input clamp voltage	$V_{CC} = \text{MIN}$	$I_I = -18 \text{ mA}$		-1.5	V
I_{IL}^*	Low-level input current	$V_{CC} = \text{MAX}$	$V_I = 0.4 \text{ V}$		-0.25	mA
I_{IH}^*	High-level input current	$V_{CC} = \text{MAX}$	$V_I = 2.4 \text{ V}$		25	μA
I_I	Maximum input current	$V_{CC} = \text{MAX}$	$V_I = 5.5 \text{ V}$		200	μA
V_{OL}	Low-level output voltage	$V_{CC} = \text{MIN}$	$I_{OL} = 12 \text{ mA}$		0.5	V
V_{OH}	High-level output voltage	$V_{CC} = \text{MIN}$	$I_{OH} = -2 \text{ mA}$	2.4		V
I_{OZL}^*	Off-state output current	$V_{CC} = \text{MAX}$	$V_O = 0.4 \text{ V}$		-100	μA
I_{OZH}^*			$V_O = 2.4 \text{ V}$		100	μA
I_{OS}^{**}	Output short-circuit current	$V_{CC} = 5 \text{ V}$	$V_O = 0.5 \text{ V}$	-30	-130	mA
I_{CC}	Supply current	$V_{CC} = \text{MAX}$			180	mA

* I/O pin leakage is worst case of IIX or IOZX; i.e., IIL and IOZH.

** Not more than one output should be shorted at a time and duration of the short circuit should not exceed one second.

ADVANCE INFORMATION

Switching Characteristics Over Operating Conditions

SYMBOL	PARAMETER		TEST CONDITIONS	STD		A		UNIT
				MIN	MAX	MIN	MAX	
t_{PD}	Input or feedback to output	Product terms P_1-P_n	$R_1 = 390 \Omega$ $R_2 = 750 \Omega$	35		30		ns
		Product term XOR		40		35		
t_{CLK}	Clock to output or feedback	20		20		ns		
t_{PZK}	Input to output enable	35		30		ns		
t_{PKZ}	Input to output disable	35		30		ns		
t_{AP}	Asynchronous preset to output	35		30		ns		
t_{CR}	Input or feedback to registered output from combinatorial configuration	95		95		ns		
t_{RC}	Input or feedback to combinatorial output from registered configuration	95		95		ns		
f_{MAX} *	Maximum frequency	Feedback ($1/t_{P1}$)		18		20		MHz
		Product terms P_1-P_n		16.7		18		
		Product term XOR	20		21.7			
		No feedback**						

* f_{MAX} is calculated and measured on initial qualifications only.

$$f_{MAX} (NO \text{ feedback}) = 1/(t_{WL} + t_{WH})$$

Programmed devices conform to Mil-Std-883, Method 5005, Group A, Subgroups 1, 2, 3, 7, 8, 9, 10 and 11.

Military 24-Pin PAL Devices

Switching Waveforms

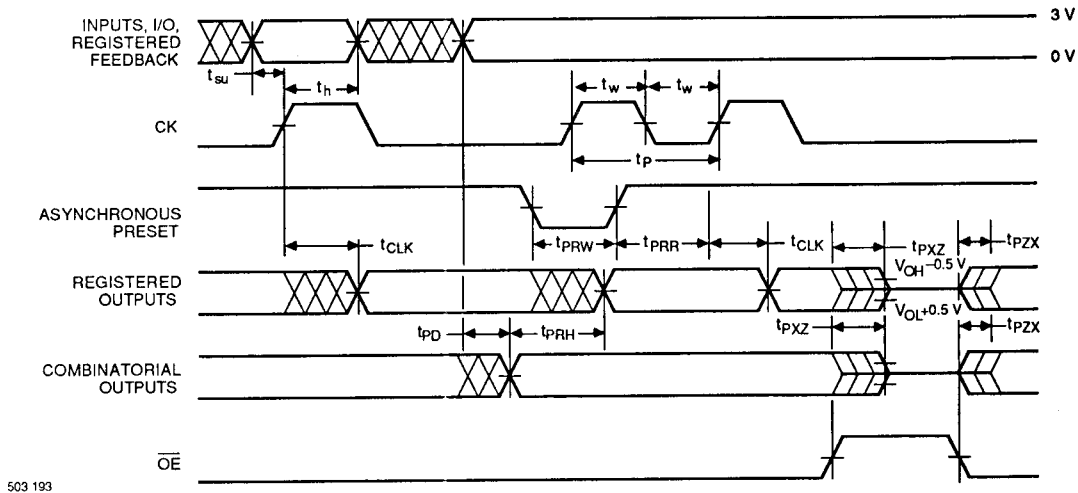

503 193

- Notes:
1. t_{PD} is tested with switch S_1 closed. $C_L = 50$ pF and measured at 1.5 V output level.
 2. t_{PZX} is measured at the 1.5 V output level with $C_L = 50$ pF. S_1 is open for high impedance to "1" test and closed for high impedance "0" test.
 3. t_{PZX} is tested with $C_L = 5$ pF. S_1 is open for "1" to high impedance test measured at $V_{OH} - 0.5V$ output level. S_1 is closed for "0" to high impedance test measured at $V_{OL} + 0.5V$ output level.
 4. Equivalent test loads may be used on automatic test equipment.

Switching Test Load

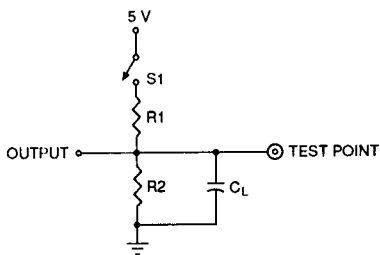

503 194

Output Register Preload PAL24XA Series, PAL24RS Series and PAL20RA10 Device

1. Raise V_{CC} to 4.5 V.
2. Disable output registers by setting pin 13 to V_{IH} .
3. Apply V_{IL}/V_{IH} to all registered output pins.
4. Pulse pin 10 to V_p then back to 0 V.
5. Remove V_{IL}/V_{IH} from all output registers.
6. Lower pin 13 to V_{IL} to enable the output registers.
7. Verify for V_{OL}/V_{OH} at all registered output pins.

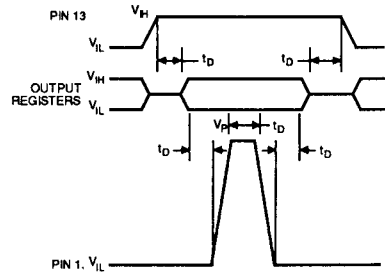

503 195

Output Register Preload PAL32VX10 Device

The preload function allows the register to be loaded from the output pins. This feature aids the functional testing of sequential designs by allowing direct setting of output states. The procedure is:

1. Raise V_{CC} to 4.5 V.
2. Disable output registers by setting pin 2 to V_{IH} (12 V).
3. Apply V_{IL}/V_{IH} to all registered output pins. Leave combinatorial outputs floating.
4. Pulse pin 10 to V_{IH} , then back to 0 V.
5. Remove V_{IL}/V_{IH} from all output registers.
6. Remove high voltage from pin 2.
7. Enable registered outputs per programmed pattern.
8. Verify for V_{OL}/V_{OH} at all registered output pins.

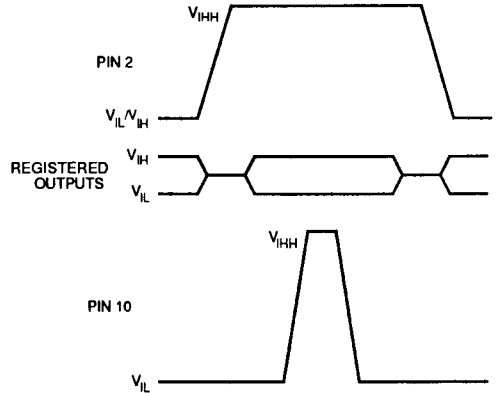

503 196

Key to Timing Diagrams

WAVEFORM	INPUTS	OUTPUTS
	DON'T CARE: CHANGE PERMITTED	CHANGING: STATE UNKNOWN
	NOT APPLICABLE	CENTER LINE IS HIGH IMPEDANCE STATE
	MUST BE STEADY	WILL BE STEADY

503 197

Military 24-Pin PAL Devices

Life Test/Burn-In Circuits

Complies with Mil-Std-883, Method 1005/1015, Condition D.

Circuit Configurations

Waveforms

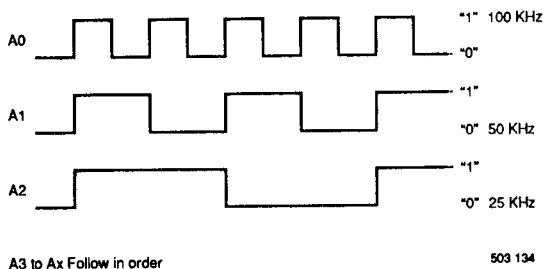

1. All Burn-In will be accomplished at 125°C +5/-0°C
2. $V_{CC} = 5.25 \text{ volts} \pm 0.25 \text{ V}$
3. All Clocks (A0 to Ax) are square wave signals 50±15% Duty Cycle, with:
 - a. "0" = -0.5 V to +0.7 V
 - b. "1" = +2.4 V to V_{CC}
 - c. Rise Time (+0.7 V to +2.4 V) < 1 μsec
 - d. Fall Time (+2.4 V to +0.7 V) < 1 μsec
4. Resistor Value
330 Ω or 470 Ω ±5%
5. All Board Components to be compatible with 150°C Ambient (Min).

PAL12L10

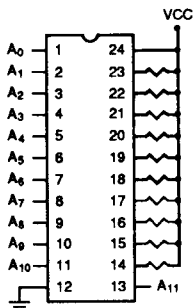

PAL14L8

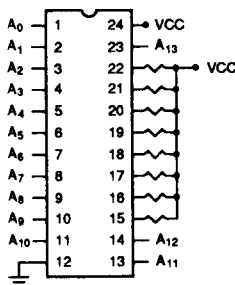

PAL16L6

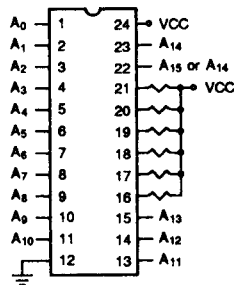

Military 24-Pin PAL Devices

Life Test/Burn-In Circuits

Complies with Mil-Std-883, Method 1005/1015, Condition D.

Circuit Configurations

PAL18L4

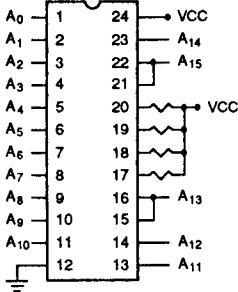

PAL20L2

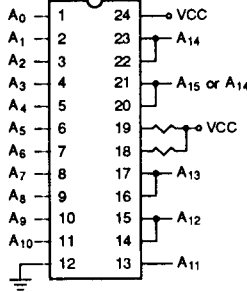

PAL20C1

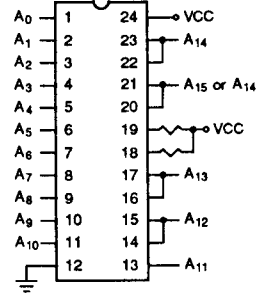

PAL8L14A

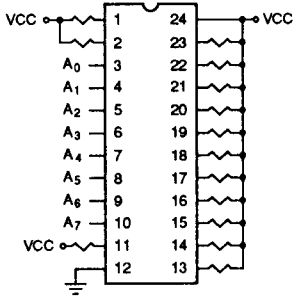

**PAL20L8A/B
PAL20L8A-2**

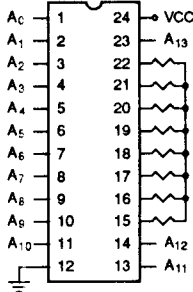

**PAL20R8A/B
PAL20R8A-2**

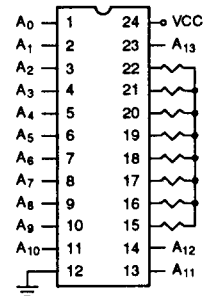

**PAL20R6A/B
PAL20R6A-2**

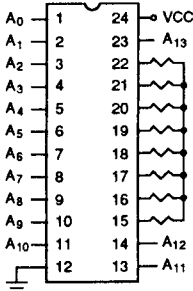

**PAL20R4A/B
PAL20R4A-2**

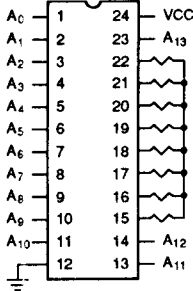

PAL20L10A

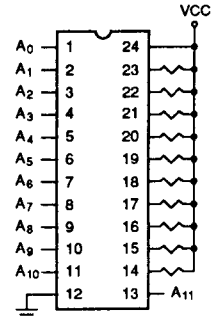

503 202

Military 24-Pin PAL Devices

Life Test/Burn-In Circuits

Complies with Mil-Std-883, Method 1005/1015, Condition D.

Circuit Configurations

PAL20X10A

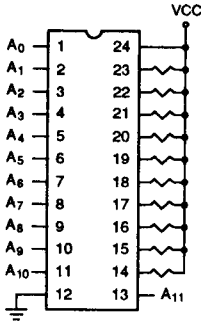

PAL20X8A

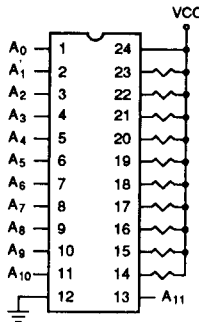

PAL20X4A

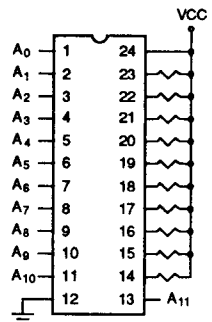

PAL20S10

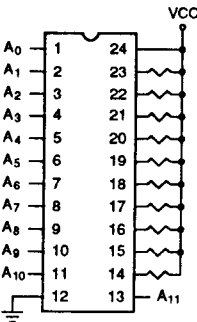

PAL20RS10

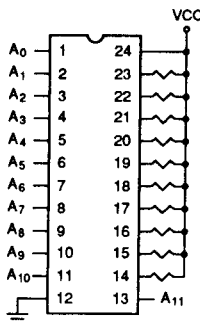

PAL20RS8

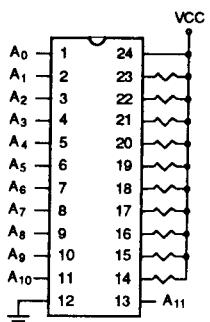

PAL20RS4

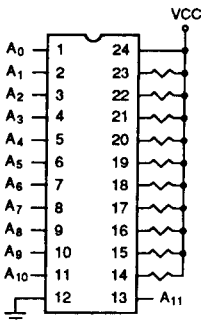

PAL32VX10/10A

